



## SOPORTE PANTALLA LED

## STACKED LED SUPPORT

Altura Height	2.11 m* (LWS-2) 7.25 ft
Superficie de trabajo Work surface	100x106/110/114 cm (3.28x3.48/3.6/3.74 ft)
Peso Weight	36 kg (LWS-2) 80 lb
Material Material	Aluminio 6082 T6 + Acero Aluminium 6082 T6 + Steel
Acabado Finish	Negro Black

## LWS-2



211cm

soportes universales  
ajustables en altura  
y profundidad

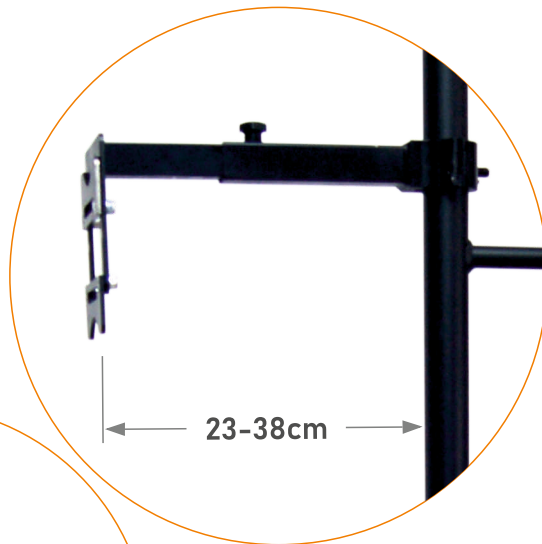

23-38cm

side entry clamp with the  
universal connection  
plate mounted

Max.  
100mm

Max. 100mm

2 estabilizadores  
ajustables frontales + 1  
posterior para nivelar el  
conjunto.

CONTRAPESOS POR METRO LINEAL  
COUNTERWEIGHT PER METER

Modelo Model	Altura Height (m)	Carga distribuida Distributed load (kg/ml)	Contrapeso Counterweight (kg/ml)
LWS-2	2	34	32
LWS-3	3	98	93
LWS-4	4	169	160

2 adjustable front spindles + 1  
adjustable back spindle, you  
can safely level the system.



### PESOS COMPONENTES COMPONENTS WEIGHTS

Modelo Model	Descripción Description	Peso (kg) Weight
LW-T05	Truss paralelo especial 0.5 m negro 0.5 m black ladder truss section	2.5
LW-T075	Truss paralelo especial 0.75 m negro 0.75 m black ladder truss section	3
LW-T1	Truss paralelo especial 1m negro 1m black ladder truss section	4
LW-B05	Base frontal 0,5 m con estabilizadores ajustables Front 0,5 m base with stabilisers	5
LW-B1	Base frontal 1 m con estabilizadores ajustables Front 1 m base with stabilisers	9
LW-B2	Base trasera con estabilizador ajustable + conos truss Rear base with stabilisers & truss eggs	13
LW-AR1	Brazo soporte ajustable pantalla Adjustable screen support arm	2
LW-U1	Pletina unión bases LW-B1 Connection plate for LW-B1 bases	2
LW-UA5	Pletina unión bases LW-B1 a 5° (175° o 185°) Connection plate for LW-B1 bases 5° (175° o 185°)	2
LW-U05	Pletina unión bases LW-B1+LW-B05 Connection plate for LW-B1+LW-B05 bases	1.5

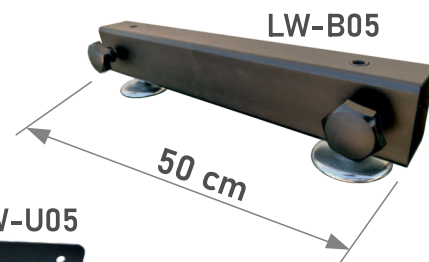
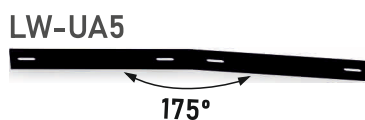
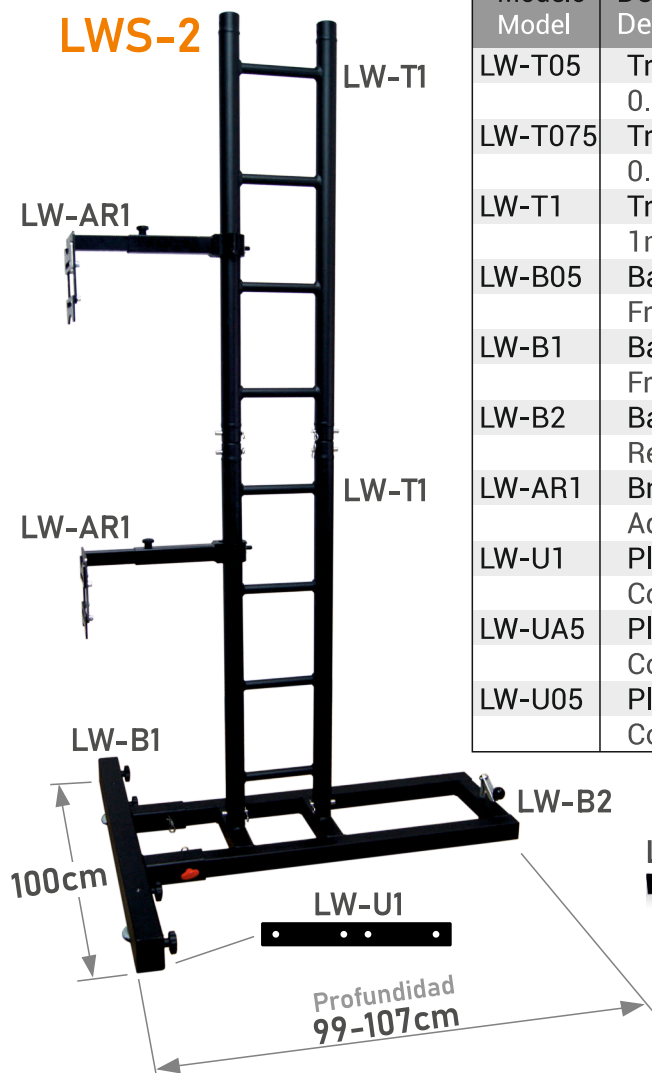

**Añade tantos módulos y paneles como necesites conectándolos con pletinas de unión.**

By using connection plate, you can easily extend you screen with another row of panels.



### STACKED LED SUPPORT

#### ACCESORIOS OPCIONALES OPTIONAL ACCESSORIES

**LWS-2**

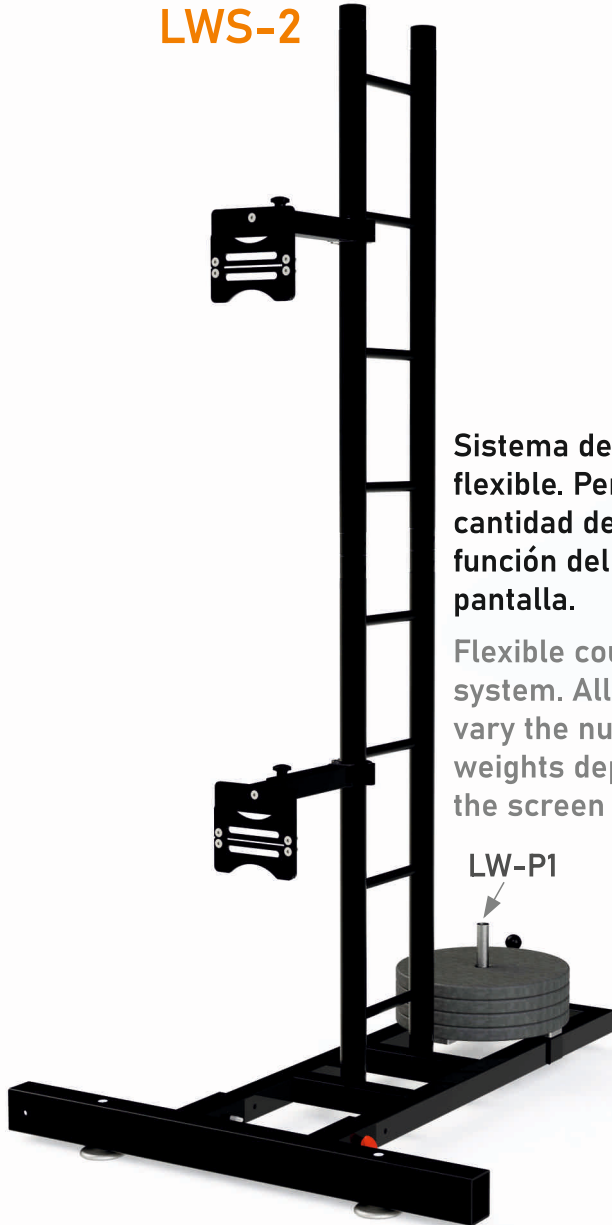

Sistema de contrapesos flexible. Permite variar la cantidad de pesos en función del tamaño de pantalla.

Flexible counterweight system. Allows you to vary the number of weights depending on the screen size.

Modelo Model	Descripción Description
LW-P1	Soporte contrapesos con barra Ø25mm* Counterweight support with Ø25mm bar*
LW-P2	Soporte contrapesos estándar 20kg* Standard 20kg counterweight support*
LW-AR2	Barra de refuerzo telescópica con abrazaderas Telescopic Reinforcement bar between stacks
LW-AR3	Barra de refuerzo fija con abrazaderas Reinforcement bar between stacks
CWA-20	Contrapesos estándar 20kg para LW-P2 Standard 20kg counterweight for LW-P2

\*Pesos NO incluidos · Weights not included



LW-P1

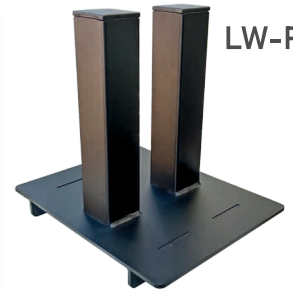

LW-P2

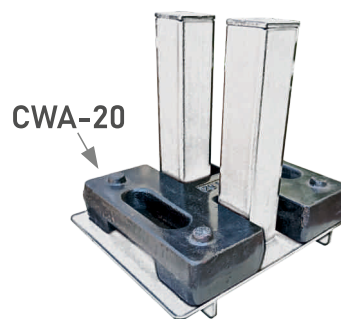

CWA-20



LW-AR2

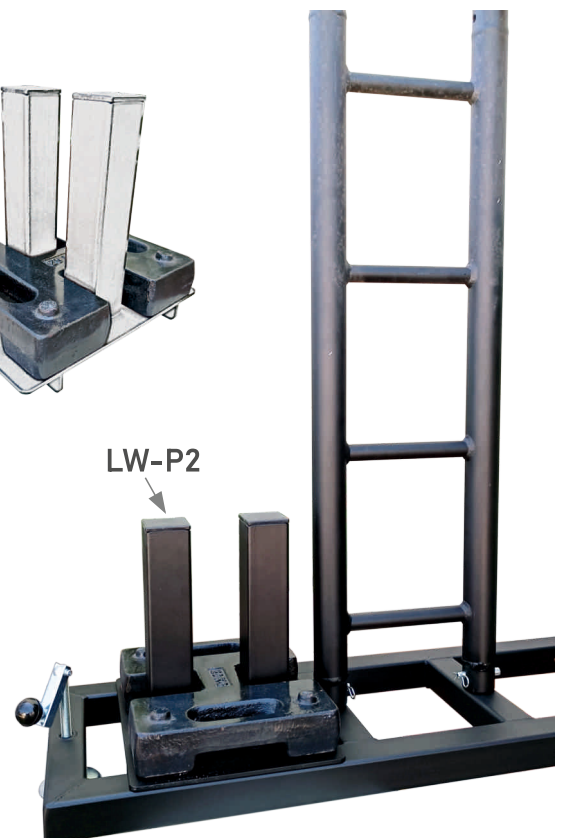

LW-P2



LW-AR3

### STACKED LED SUPPORT

#### MEDIDAS MEASURES

	LWS-1	LWS-2	LWS-3	LWS-4
Altura (m) <i>Height (ft)</i>	1.11 3.64	2.11 6.92	3.11 10.20	4.11 13.48
Peso (kg) <i>Weight (lb)</i>	28 62	36 79	44 97	52 115
Superficie de trabajo ancho x profundo (m) <i>Work surface width x depth (ft)</i>	100 x 106/110/114 3.28 x 3.48/3.6/3.74			

#### COMPONENTES INCLUIDOS INCLUDED COMPONENTS

Ref. Ref.	Descripción Description	LWS-1 Uds. Units	LWS-2 Uds. Units	LWS-3 Uds. Units	LWS-4 Uds. Units
LW-T1	Truss paralelo especial 1m negro <i>1m black ladder truss section</i>	1	2	3	4
LW-B1	Base frontal con estabilizadores ajustables <i>Front base with stabilisers</i>	1	1	1	1
LW-B2	Base trasera con estabilizador ajustable + conos truss <i>Rear base with stabilisers &amp; truss eggs</i>	1	1	1	1
LW-AR1	Brazo soporte ajustable pantalla <i>Adjustable screen support arm</i>	1	2	3	4
LW-U1	Pletina unión bases LW-B1 <i>Connection plate for LW-B1 bases</i>	1	1	1	1

